

FOTILE

USER'S HANDBOOK

Please read this instruction manual carefully before using

BUILT-IN GAS COOKTOP

GAS78307 GAG86309

Every effort has been made to ensure that the information given in this manual is correct at the time of printing. However, due to the continuous product improvement, FOTILE reserves the right to make changes to the products and technical data without prior notice.

Ningbo Fotile Kitchenware Co., Ltd.
No.218 Binhai 2 Road, Hangzhou Bay New District, Cixi, Zhejiang, China
Tel: 0086-574-23456666
Website:WWW.FOTILE.COM
E-mail:overseas@fotile.com

NUGM0030

CONTENT

WARNING AND SAFETY INSTRUCTIONS	2
USAGE PRECAUTIONS	4
PACKAGE DISPOSAL INSTRUCTIONS - ENVIRONMENT POLICY ----	6
PACKING LIST	6
INSTRUCTIONS FOR THE INSTALLER	6
INSTRUCTIONS FOR THE USER	9
CLEANING AND MAINTENANCE	11
TROUBLESHOOTING	13
WIRING DIAGRAM	14
WARRANTY CARD	14

⚠ WARNING: If the information in this manual is not followed exactly, a fire or explosion may result causing property damage, personal injury or death.

- Do not store or use gasoline or other flammable vapors and liquids in the vicinity of this or any other appliance.
- WHAT TO DO IF YOU SMELL GAS
 - Do not try to light any appliance.
 - Do not touch any electrical switch.
 - Do not use any phone in your building.
 - Immediately call your gas supplier from a neighbor's phone. Follow the gas supplier's instructions.
 - If you cannot reach your gas supplier, call the fire department.
- Installation and service must be performed by a qualified installer, service agency or the gas supplier.



INSTRUCTIONS FOR THE USER: these provide recommendations for use, a description of the controls and the correct procedures for cleaning and maintaining the appliance



INSTRUCTIONS FOR THE INSTALLER: these are intended for the qualified engineer who install, commission and test the appliance

WARNING AND SAFETY INSTRUCTIONS



Special version:

Please properly use the appliance, strictly complying with the user manual. FOTILE company will not bear responsibility for property loss and personal injury due to improper use.



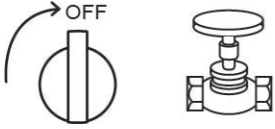

⚠ Warning: It may cause people danger, serious injury or fire, if you ignore the following contents and improperly operate.





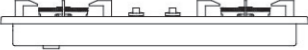

⚠ Strictly Execute

	The gas cooktop can be used only in domestic kitchen. Please do not install it in the bath room, bed room, basement or places that are flammable, explosive and corrosive.
	Such works as gas cooktop installation, refitting, removal, dismantle, repair should be done installed by authorized installers certificated companies and operated by professional people.
	Some gas suppliers provide " Gas Usage Safety Manual " You must ask gas operating agency for " Gas Usage Safety Manual " , and comply with it. The appliance must be installed in accordance with AS5601, local gas authority regulations, the gas cooktop will go wrong due to gas pressure abnormality.
	To prevent asphyxiation, after installation and before usage, please check you cannot smell gas. Keep the room ventilated when daily use.
	If there is gas leak, please turn off the switch knob and appliance isolating gas valve soon, open the window, contact FOTILE service center to repair it. At this time, don't touch the power switch or ignite, and don't use mobile phone, fixed-line telephone etc, to prevent explosion.
	Please don't let the gas cooktop work at strong wind disturbing environment, because it will influence the normal burning, even failed to work.

	If there happens burning due to over high oil temperature, please cover the source of fire with large size metal items, like iron pot cover (please don't use water), and close the general gas valve.
	Please don't go out or go to bed when gas cooktop is working. Please turn off the knobs and general gas valve after usage and repeatedly check whether they are turned off before you sleep or go out.
	Used batteries must be placed into appointed used batteries reclamation bin or recyclable garbage can.
	Please keep the product plastic package away from the infants, to avoid suffocation, etc.



⚠ Forbidden

	Do not modify this appliance.
	Please confirm the gas type is the same with nameplate indicate before using. It is forbidden to change into other gas type, especially the man-made gas which produces CO.
	This gas cooktop is for heating cook utensil, don't use it for drying towels, clothes, etc. Where this appliance is installed in marine craft or in caravans, it shall not be used as a space heater.
	Please don't turn on the gas cooktop for heating when there is no pan or there is no food in the pan. It may damage the range hood which is above the stove, even will burn the grease inside of the range hood and cause fire accident.
	Please don't touch the cooktop that is off work for a short while, to avoid scalding.
	Do not use or store flammable materials in the appliance storage drawer or near this appliance.

	Please don't place any acidic or alkaline substance on the cooktop (vinegar, lemon juice, etc).
	Do not place anything, e.g. flame tamer, asbestos mat, between pan and pan support as serious damage to the appliance may result.
	Do not remove the pan support and enclose the burner with a wok stand as this will concentrate and deflect heat onto the hotplate.
	Do not use large pots or heavy weights which can bend the pan support or deflect flame onto the hotplate.
	Locate pan centrally over the burner so that it is stable and does not overhang the appliance.
	Use only a wok support supplied or recommended by the manufacturer of the appliance.
	Do not spray aerosols in the vicinity of this appliance while it is in operation.

 The glass used in FOTILE products is tempered glass, and the tempering mechanism of glass decides that there is extremely small probability for tempered glass self explosion. Once it happens self explosion do not due to improper use, we promise to replace the tempered glass for free.

USAGE PRECAUTIONS

-  This manual is an integral part of the appliance. Take good care of it and keep it on hand throughout the hob's lifecycle. We urge you to read this manual and all the information it contains carefully before using the appliance. The manufacturer declines all liability for uses other than those stated above.
-  This appliance is not connected to a combustion products exhaust system device. It shall be installed and connected in accordance with current installation regulations. Particular attention shall be paid to the relevant requirements regarding ventilation. The use of inappropriate hob guards can cause accidents.



Before installation, please ensure that the local distribution conditions (Type of the gas and gas pressure) and the adjustment of the appliance are compatible.

The appliance are designed for using LP gas or Nat. gas.

The adjustment conditions for this appliance are stated on the label (or data plate)



Never use this appliance for heating rooms.



Never use packaging residues unattended in the house. Separate the various waste packaging materials by type and consign them to the nearest separate disposal centre.



This appliance is marked according to the European directive 2002/96/ec on Waste Electrical and Electronic Equipment (WEEE). This guideline is the frame of European-wide validity of return and recycling on waste electrical and electronic equipment.



Never obstruct the openings and slits provided for ventilation and heat dispersal.



The nameplate with the technical data, serial number and mark are in a visible position underneath the appliance. The nameplate must never be removed where the data plate cannot be easily seen at installation. The duplicate data plate must be fitted in a adjacent position where it can be seen by the operator.



Poisoning Hazard.

Never use this appliance as a space heater to heat or warm the room.

Doing so may result in carbon monoxide poisoning and overheating of the appliance.

Failure to follow this advice may result in poisoning or death.



Hot Surface Hazard

This appliance becomes hot during use.

Do not touch the cooktop components, burners, pan supports or the ceramic glass when hot.



Fire Hazard

Never leave the appliance unattended when in use. Boilover causes smoking and greasy spillovers that may ignite.

Failure to follow this advice may result in serious injury.



Explosion Hazard

Do not use cooktop where flammable materials such as gasoline near this appliance.

Do not spray aerosols in the vicinity of this appliance while it is in operation.

Failure to follow this advice may result in death or serious injury.



The appliance is intended for use by adults. Keep children at a safe distance and never allow them to play with it.



Always check that the control knobs are turned off after each use.



The manufacturer declines all responsibility for injury or damage caused by failure to comply with the above regulations or deriving from tampering with even just one part of the appliance and the use of non-original spare parts.

PACKAGE DISPOSAL INSTRUCTIONS - ENVIRONMENT POLICY

Our products are only packaged using non-pollutant, environment-friendly, recyclable materials. We urge you to cooperate by disposing of the packaging properly. Contact your local dealer or the competent local organizations for the addresses of collection, recycling and disposal facilities. Never leave all or part of the packaging lying around. Packaging parts, and especially plastic bags, may represent a suffocation hazard for children.

Your old appliance must also be disposed of properly. Important: deliver the appliance to your local organization authorized to collect scrapped appliances. Proper disposal allows the intelligent recovery of valuable materials.



Never leave packaging residues unattended in the house. Separate waste packaging materials by type and consign them to the nearest separate disposal centre.



The inside of the appliance should be cleaned to remove all manufacturing residues. For further information, see point "CLEANING AND MAINTENANCE".

PACKING LIST

Please pay attention to the amount of accessories, and make sure there is no scarcity or shatters

(1) Please contact with the dealer when our company or the dealer is responsible for the above carelessness.

(2) Please contact the nearest service center engaged by special arrangement if the user should undertake the responsibility.

	Complete Appliance	1		D battery(suggest alkaline battery)	1
	User Manual & Warranty Card	1		Connector with Seal ring	1
	Pressure regulator	1			

INSTRUCTIONS FOR THE INSTALLER



The minimum distances given in these Installation instructions are to combustible surfaces, and must be observed to ensure safe operation. Failure to do so increases the risk of fire.

The cabinetry and venting hood should be installed first to prevent damage to the cook top.



The following operation requires building and/or carpentry work, so it must be carried out by a qualified person.

Installation can be carried out with various materials such as masonry, metal, solid wood or plastic laminated wood, as long as they are heat-resistant (T90°C)

■ Safety distances above the Appliance

The minimum safety distance given by the hood manufacturer must be maintained between the cook top and the hood above it. See the installation instructions of the hood for these safety measurements. If the hood manufacturer's instructions are not available or if flammable objects are installed over the cook top (e.g. cabinets, utensil rail, etc.), a minimum safety distance of 30" (760 mm) must be maintained. (figure 1)

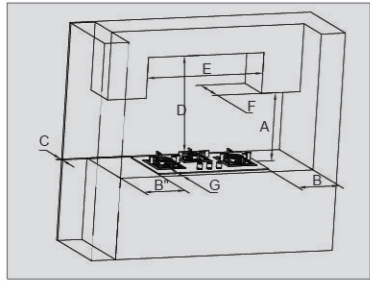

figure 1

Minimum vertical clearances of 18 inches from top surface unit to side cabinets [A]. Minimum horizontal distance(s) from sides and back of appliance to adjacent vertical combustible walls extending above the top panel, 6 inches from the left side[B], 6 inches from right side[B], 2 inches from rear wall [C]. Minimum clearance to combustible construction centered above cooking surface: vertical 30 inches[D], horizontal 30 inches[E]. The unit overhead cabinet maximum depth: 13 inches [F]. Minimum horizontal distance from front edge of counter to front side of appliance, 1 inches [G].

If there are several appliances beneath a hood, and they have different minimum safety distances always observe the greatest distance.

■ Installation dimensions

Create an opening with the dimensions shown as figure 2 . Place the hob in the cut out, and then make a hole with dimensions 150mm*150mm under the cooktop and on the side of the kitchen cupboard in order to meet air supply.

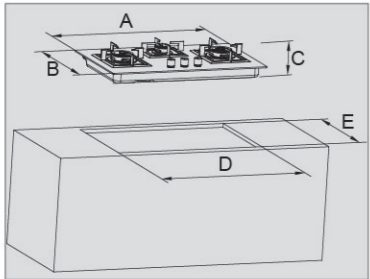

figure 2

	A	B	C	D	E
GAG86309	33.86	19.69	4.92	32.13	18.11
GAS78307	30.7	17.72	6.14	27.87	15.28

unit: inch

■ Electrical connection

- This appliance uses a DC1.5V (D SIZE) battery power supply.
- Install the battery (figure 3)

Open the battery box at the bottom of the appliance, the cathode connect the spring end A and press the spring; the anode connect the end B of the battery box, make sure that the battery is put in the right direction and then close the battery box.

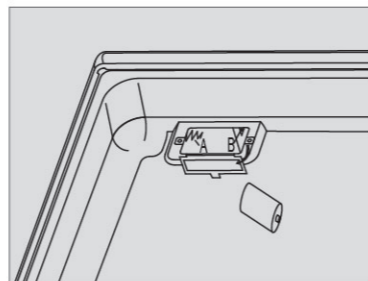

figure 3

■ Gas connection

Installation and service must be performed by a qualified installer, service agency or gas supplier. In Massachusetts installation must be performed by a licensed plumber / gas fitter.

This appliance must be installed with a shut off valve and the included gas pressure regulator. Both the valve and the regulator must be easily accessible to the consumer to turn on or shut off the gas supply after the appliance is installed.

This appliance and its individual shut off valve must be disconnected from the gas supply during any pressure testing of that system performed in excess of ½ psi. The appliance must be isolated from the gas supply line by closing its individual manual shut off valve at test pressures equal to or less than ½ psi.

Any pipe connections must be made using a thread sealant approved for gas connections. Failure to correctly install these items could lead to a gas leak and subsequent explosion.

Leak testing of the appliance shall be conducted according to the manufacturer's instructions.

 The gas connection must be made in accordance with local codes or , in the absence of local codes, with the National Fuel Gas Code, ANSI Z 21.1 / NFPA 54 for the USA or the current Can / CGA B 149.1 and .2 Installation Codes for gas burning appliances for Canada.

Make sure that the maximum gas supply pressure before the gas pressure regulator is never more than ½ psi for both natural gas and LP gas. The minimum required gas supply pressure to get the required gas inputs

- 4" W.C. for natural gas
- 10" W.C. for LP gas.

■ Gas pressure regulator

The pressure regulator is already settled for using natural gas or LP gas.

The adjusted pressure is:

- natural gas 4" W.C.
- LP gas 10" W.C.

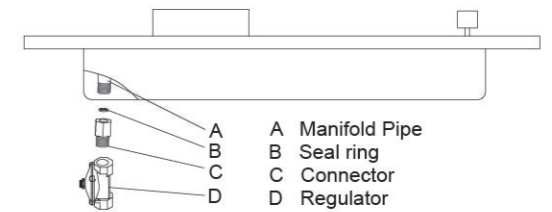



figure 4

As shown in figure 4 the included regulator must be used when connecting the FOTILE appliance to your gas supply. This item has been customized by FOTILE to meet all applicable safety requirements. Make sure the regulator is easily accessible for adjustment after the appliance has been installed.

 After connecting the appliance check all fittings for gas leaks e.g. with soapy water.

When installed properly, the flame will be steady and quiet. It will also have a sharp, blue inner core that will vary in length proportional to the burner size. Flame adjustment will not be necessary.

Install the flame spread cap

Figure 5 shows the large burner and Figure 6 shows the small burner.

To fix the burner, please do as below: Point the locating pin A to the locating hole D and point the locating pin B to the locating hole C. If there's a small burner, put the part E to the part F. Please make sure the fire caps are placed right and they can't be turned to the left or right side.

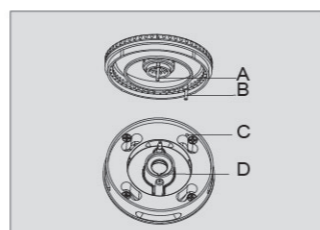

figure 5

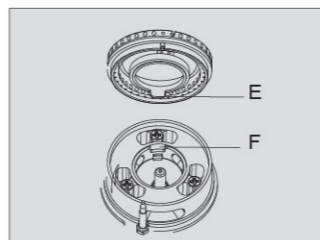

figure 6

Check that all the burners are operating correctly. The flame must not go out on the lowest setting, or when the control is turned quickly from a high to a low setting. On the highest setting, the flame must have a distinctive and visible core.

INSTRUCCIONES PARA EL USUARIO

About your new cooktop

The control knobs can be removed for cleaning by just pulling.

Safety feature: flame failure device

Your cooktop is equipped with flame failure device: the gas supply will automatically be cut off to a burner that is accidentally blown out by a draught or extinguished by a spill.

Specifications and structure

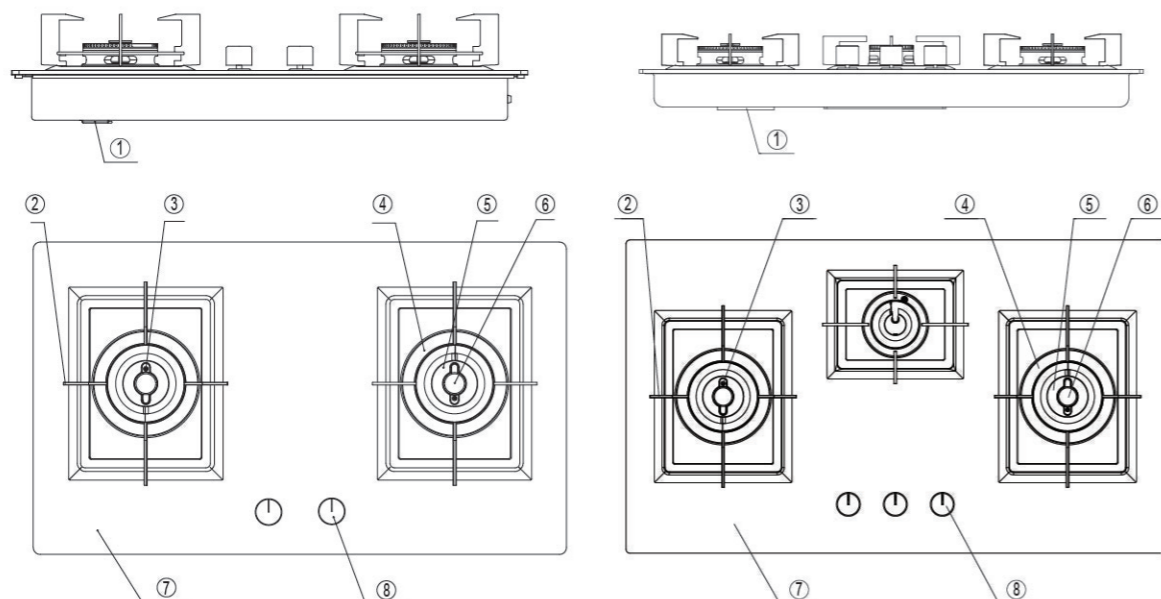

- 1. Battery box
- 2. Pan support
- 3. Ignition pin
- 4. External Flame Cap
- 5. Thermocouple
- 6. Internal Flame Cap
- 7. Panel
- 8. Knob



a. Be careful the pot (pan) is too hot to cause fire when cooking with vegetable oil and animal fat oil. When cooking with such kind of oil, please don't leave it alone after you put the food into the pot (pan).

b. The stove will heat when using, please keep it off heating items. Such metal objects as knife, fork, spoon and cover, should not be placed on the stove to prevent heat conduction.

Burner and nozzle date table

Gas type	Model	Heat input (BUT/HR)				Nozzle diameter(mm)		
		Left	Middle	Right	Total	Left	Middle	Right
Nat. Gas 4" W.C.	GAG86309	14800	5800	14800	35400	1.20*2&0.85	1.15	1.20*2&0.85
	GAS78307	14800	5800	14800	35400	1.20*2&0.85	1.15	1.20*2&0.85
LP gas 10" W.C.	GAG86309	13000	5000	13000	31000	0.66*2&0.55	0.66	0.66*2&0.55
	GAS78307	13000	5000	13000	31000	0.66*2&0.55	0.66	0.66*2&0.55

Using the gas hob

The burner it controls is shown next to each knob. The appliance is equipped with an electronic ignition device. Simply press the knob and turn it anti-clockwise to the maximum flame symbol (2), until the burner lights. If it does not light within the first 15 seconds, to turn the knob off (1) and wait at least 60 seconds before trying to light the burner again.

On models equipped with valves, once the burner is ignited, to keep the knob pressed down for a few seconds to allow the thermocouple to heat up. The burner may go out when the knob is released: in this case, the thermocouple has not heated up sufficiently. To wait a few moments and repeat the operation, and to keep the knob pressed down for longer. Once the burner has been ignited, the flame can be regulated as required (3, 4, 5). After each use of the hob, always check that the control knobs are turned to off (1).

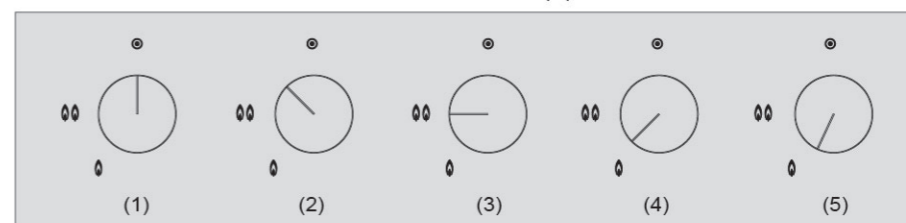

figure 6



If the flame goes out accidentally a safety device will be tripped about 20 seconds later, and cut off the gas supply even if the gas tap is open. In this case, to turn the knob back to the off position and wait at least 60 seconds before trying to relight the burner.

Selection of pans

Please choose the proper pan, and you will enjoy better cooking experience.

1. Please make sure the diameter of the pan used is equal to or more than cook area.
2. To avoid rubbing the surface, using clean and bottom-slick pan.
3. To get best cooking results, the bottom of porcelain enamel steel pan shall be 2-3mm thick, the bottom of stainless steel filled pan shall be 4-6mm thick.

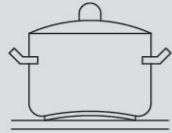

Wrong

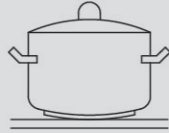

Wrong

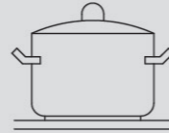

Right

Burner	Minimum	Maximum
Small	N/A	20cm
Large	N/A	27cm

 The use of a gas cooking appliance results in the production of heat, moisture and products of combustion in the room in which it is installed. Ensure that the kitchen is well ventilated especially when the appliance is in use: keep natural ventilation holes open or install a mechanical ventilation device (mechanical extractor hood).
Prolonged intensive use of the appliance may call for additional ventilation, for example opening of a window, or more effective ventilation, for example increasing the level of mechanical ventilation where present

CLEANING AND MAINTENANCE

Notice

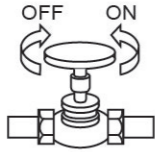

Before cleaning and maintaining the stove, switch off the general gas valve and wait for it cooling down thoroughly.



When you maintain the following, make sure not disassemble the safety device or gas duct parts.



Please contact FOTILE service center if there is abnormality.

Check



Please don't stack the inflammable around the gas stove.



Never let the spilt block the burner. Make sure there is no food residua, foreign matter and water touch the ignition and thermocouple head.

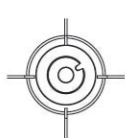

Burners, flame caps and pan supports shall be correctly positioned.



The flame should not be irregular.



In case of hotplate glass breakage, shut immediately off all burners and any electrical heating element and isolate the appliance from the power supply. Do not touch the appliance surface. Do not use the appliance.



Please don't wipe the stainless steel panel with sharp material like steel wire ball, etc. It will greatly shorten the cooktop lifespan.

Maintenance

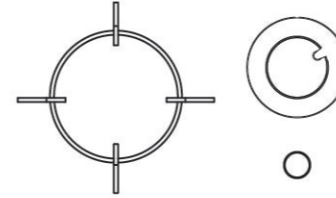

1. Before cleaning, please take remove pan supports and flame caps.



Warm water

Neutral

2. Movable parts of burner like copper flame cap must be washed with warm water and neutral cleanser frequently. Remove the nugget and dry it, then use the stove.



Neutral

3. Please use neutral cleanser which is without corrosiveness, to clean the stainless steel panel and burner. Never use chlorine-base cleanser to clean glass.

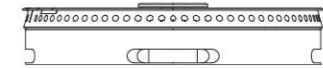

4. Make sure that there is no carbon in the firehole, and no jam.



Graininess Cleanser



Aculeated Articles (Knife etc.)



Clean Ball

5. Please don't use such aculeated articles as graininess abluent (putty-powder), clean ball, knife, etc. to clean the residual stubborn besmirch in the burners. Otherwise, it will make the kitchen countertop go wrong or fray the assembly surface, then influence cooktop lifespan.



6. After cleaning, dry them well and install them correctly.

TROUBLESHOOTING

■ Troubleshooting for gas burner Servicing / repairs must only be carried out by an authorized person

Problems	The cause of problem	Settlements for the problems
It won't fire	It is forgotten to open the general gas valve	Firstly turn off the knob, and then open the general gas valve
	Air is mixed into the gas pipe	Ignite repeatedly until the air is absolutely discharged
	The rubber tube bends or flattens	Unfold or change the rubber tube
	Ignition device and insulation point is dirty and damp	Clean it with a dried cloth
	Safety valve doesn't open	Press and turn the knob to intense fire, make sure the hob is fired and keep on pressing for 3 to 4 seconds
	The battery is out of use; the battery doesn't touch well; or the battery is up side down	Change the battery or refix the battery
	There's problem with the ignition device or the ignition pin is not in the right position	Ask the professional maintenance man for maintaining
There is a warning tone when ignition	The battery is low	Change the battery
Gas leak	The rubber tube cracks or breaks	Change the rubber tube by authorised person
	The rubber tube joint doesn't connect well with rubber tube or other tube	Replace hose
Unstable flame	Whether the LPG is used up	Change into a new bottle of LPG
Soft and yellow flame	The throttle is not properly adjusted, and the air is insufficient	Gradually enlarge the throttle until the flame turns normal blue
The flame escapes from the dire hole or flameout is with fulmination	The throttle is not properly adjusted, and the air is insufficient	Gradually enlarge the throttle until the flame turns normal blue
Few flames	Injector or stopcock is jammed	
The flame isn't in uniform length and the flame is yellow	Fire lid is not properly covered, and there' s charcoal or other dirt stuffing the fire hole	Make sure that the fire lid is on the right position ; get rid of the dirt in the fire hole
The flame accidentally goes red	Under a certain climate, the gas is with much humidity	The flame turns red because there's calcium in water, so don't worry about it

WIRING DIAGRAM

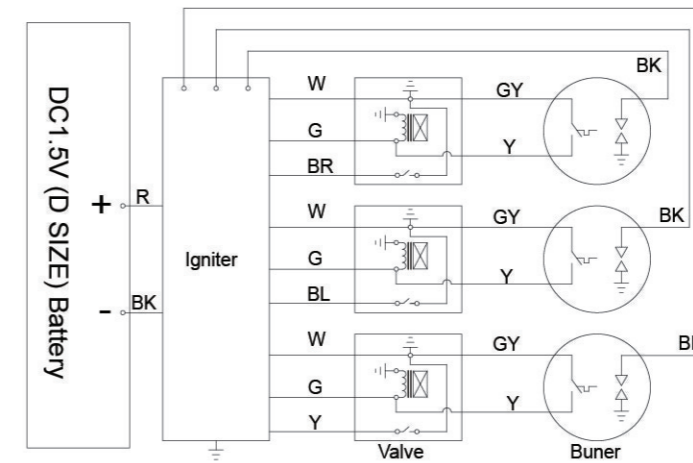

WARRANTY CARD

⚠ **Warning:** Do not modify this appliance.

Name		Date of purchase		Serial NO. of the Invoice	
Address (post code)				Tel	
Type of product			Serial NO. of the appliance		
Repair Record(for repairer)					
Content					Date