



INSPIRING THE WORLD'S KITCHEN



## OVER THE RANGE MICROWAVE

# **COS-30190RM2SS**

## USER MANUAL & CARE GUIDE

### IMPORTANT SAFETY INSTRUCTIONS

Carefully read the following Important information regarding installation safety and maintenance. Keep these instruction for future reference.

**COS-30190RM2SS**

**USER MANUAL**

## THANK YOU FOR YOUR PURCHASE

**Thank you for your purchase. We know that you have many brands and products to choose from and we are honored to know that you have decided to take one of our products into your home and hope that you enjoy it.**

COSMO appliances are designed according to the strictest safety and performance standard for the North American market. We follow the most advanced manufacturing philosophy. Each appliance leaves the factory after thorough quality inspection and testing. Our distributors and our service partners are ready to answer any questions you may have regarding how to install, use and care for your products. We hope that this manual will help you learn to use the product in the safest and most effective manner .

If you have any questions or concerns, please contact the dealer from whom you purchased it, or contact our Customer Support at:

**1-888-784-3108.**

### Specifications

Model:	COS-3019ORM2SS
Rated Voltage:	120V~60Hz
Rated Input Power(Microwave):	1550W
Rated Output Power(Microwave):	1000W
Oven Capacity:	53L / 1.9 cu ft
Turntable Diameter:	Ø345mm / 13.6 "
External Dimensions:	29.8" x 16.4" x 15.4"
Net Weight:	Approx. 57.3 lbs

## IMPORTANT SAFETY INSTRUCTIONS

BEFORE YOU BEGIN:

Please Read all instructions completely and carefully.  
Save these instructions for future references.

### PRECAUTIONS TO AVOID POSSIBLE EXPOSURE TO EXCESSIVE MICROWAVE ENERGY

- Do not attempt to operate this oven with the door open since operation can result in harmful exposure to microwave energy. It is important not to interfere with or tamper with the safety interlocks.
- Do not place any object between the oven front face and the door or allow soil or cleaner residue to accumulate on sealing surfaces.
- Do not operate the oven if it is damaged. It is particularly important that the oven door closes properly and that there is no damage to the:
  - DOOR (bent)
  - HINGES AND LATCHES (broken or loosened)
  - DOOR SEALS AND SEALING SURFACE
- The oven should not be adjusted or repaired by anyone except properly qualified service personnel.

### RADIO INTERFERENCE

- Operation of the microwave oven may cause interference to your radio, TV or similar equipment.
- When there is interference, it may be reduced or eliminated by taking the following measures:
  - Clean door and sealing surface of the oven
  - Reorient the receiving antenna of radio or television.
  - Relocate the microwave oven with respect to the receiver.
  - Move the microwave oven away from the receiver.
  - Plug the microwave oven into a different outlet so that microwave oven and receiver are on different branch circuits.

### UTENSILS

**CAUTION - Personal Injury Hazard**

Tightly-closed utensils could explode. Closed containers should be opened and plastic pouches should be pierced before cooking.

See the instructions on "Materials you can use in microwave oven or to be avoided in microwave oven."

There may be certain non-metallic utensils that are not safe to use for microwaving. If in doubt, you can test the utensil in question following the procedure below.

Utensil Test:

- Fill a microwave-safe container with 1 cup of cold water (250ml) along with the utensil in question.
- Cook on maximum power for 1 minute.
- Carefully feel the utensil. If the empty utensil is warm, do not use it for microwave cooking.
- Do not exceed 1 minute cooking time.

# IMPORTANT SAFETY INSTRUCTIONS

When using electrical appliances basic safety precautions should be followed including the following:

**WARNING** - To reduce the risk of burns, electric shock, fire, injury to persons or exposure to excessive microwave energy:

1. Read all instructions before using the appliance.
2. Read and follow the specific: "PRECAUTIONS TO AVOID POSSIBLE EXPOSURE TO EXCESSIVE MICROWAVE ENERGY" found on page 3.
3. This appliance must be grounded. Connect only to properly grounded outlet. See "GROUNDING INSTRUCTIONS" found on page 5.
4. Install or locate this appliance only in accordance with the provided installation instructions.
5. Some products such as whole eggs and sealed containers - for example, closed glass jars - are able to explode and should not be heated in this oven.
6. Use this appliance only for its intended use as described in the manual. Do not use corrosive chemicals or vapors in this appliance. This type of oven is specifically designed to heat, cook or dry food. It is not designed for industrial or laboratory use.
7. As with any appliance, close supervision is necessary when used by children.
8. Do not operate this appliance if it has a damaged cord or plug, if it is not working properly, or if it has been damaged or dropped.
9. This appliance should be serviced only by qualified service personnel. Contact nearest authorized service facility for examination, repair, or adjustment.
10. Do not cover or block any openings on the appliance.
11. Do not store this appliance outdoors. Do not use this product near water - for example, near a kitchen sink, in a wet basement, near a swimming pool, or similar location.
12. Do not immerse cord or plug in water.
13. Keep cord away from heated surface.
14. Do not let cord hang over edge of table or counter.
15. When cleaning surfaces of door and oven that comes together on closing the door, use only mild, nonabrasive soaps, or detergent applied with a sponge or soft cloth.
16. To reduce the risk of fire in the oven cavity:
  - (1). Do not overcook food. Carefully attend appliance when paper, plastic, or other combustible materials are placed inside the oven to facilitate cooking.
  - (2). Remove wire twist-ties from paper or plastic bag before placing bag in oven.
  - (3). If material inside of the oven ignite, keep oven door closed, turn oven off, and disconnect the power cord, or shut off power at the fuse or circuit breaker panel.
  - (4). Do not use the cavity for storage purposes. Do not leave paper products, cooking utensils, or food in the cavity when not in use.
17. Liquids, such as water, coffee, or tea are able to be overheated beyond the boiling point without appearing to be boiling. Visible bubbling or boiling when the container is removed from the microwave oven is not always present.

**THIS COULD RESULT IN VERY HOT LIQUID SUDDENLY BOILING OVER WHEN THE CONTAINER IS DISTURBED OR A UTENSIL IS INSERTED INTO THE LIQUID**

//continued on next page..

- To reduce the risk of injury to persons:
- **DO NOT OVERHEAT** the liquid
- Stir the liquid both before and halfway through heating it.
- Do not use straight-sided containers with narrow necks.
- After heating, allow the container to stand in the microwave oven for a short time before removing the container.
- Use extreme care when inserting a spoon or other utensil into the container.
- Do not mount over sink.
- Do not store anything directly on top of the appliance surface when the appliance is in operation.
- Clean ventilation hoods frequently - grease should not be allowed to accumulate on hood or filter.
- When flaming foods under the hood, turn fan on.
- Use care when cleaning the vent-hood filter. Corrosive cleaning agents such as lye-based oven cleaners may damage the filters.
- Suitable for use above both gas and electric cooking equipment.

## GROUNDING INSTRUCTIONS

This appliance must be grounded. In the event of an electrical short circuit, grounding reduces the risk of electric shock by providing an escape wire for the electric current. This appliance is equipped with a cord having a grounding wire with a grounding plug. The plug must be plugged into an outlet that is properly installed and grounded.

**WARNING** - Improper use of the grounding can result in a risk of electric shock.

Consult a qualified electrician or serviceman if the grounding instructions are not completely understood, or if doubt exists as to whether the appliance is properly grounded. If it is necessary to use an extension cord, use only a 3-wire extension cord that has a 3-blade grounded plug, and 3-slot receptacle that will accept the plug on the appliance. The marked rating of the extension cord shall be equal to or greater than the electrical rating of the appliance.

**DANGER** - Electric Shock Hazard

Touching some of the internal components can cause serious personal injury or death. Do not disassemble this appliance.

**WARNING** - Electric Shock Hazard

Improper use of the grounding can result in electric shock. Do not plug into an outlet until appliance is properly installed and grounded.

1. A short power-supply cord is provided to reduce the risks resulting from becoming entangled in or tripping over a longer cord.
2. Longer cord sets or extension cords are available and may be used if care is exercised in their use.
3. If a long cord or extension cord is used:
  - (1) The marked electrical rating of the cord set or extension cord should be at least as great as the electrical rating of the appliance.
  - (2) The extension cord must be a grounding-type 3-wire cord.
  - (3) The longer cord should be arranged so that it will not drape over the counter top or tabletop where it can be pulled on by children or tripped over unintentionally.

**SAVE THESE INSTRUCTIONS**



# INDEX

SAFETY PRECAUTIONS .....	3-5
SETUP / PARTS LIST .....	8-9
CONTROL PANEL .....	10-11
- TIME SET .....	12
- MANUAL COOKING .....	13-16
- PRESET FUNCTIONS .....	17
USING THE RACK .....	18
MANUAL DEFROST .....	19
SENSOR COOKING .....	20-22
ONE TOUCH COOKING .....	23-25
AUTO COOKING .....	26-28
DINNER RECIPES .....	29-32
AUTO DEFROST .....	33-37
CONVENIENT FEATURES .....	37
- CLOCK .....	38
- CONTROL LOCK .....	39
- POWER SAVE .....	40
- SOUND LEVELS .....	41
- FILTER RESET .....	42
- LANGUAGE SETTINGS .....	43
- WEIGHT SETTINGS .....	44
KITCHEN TIMER .....	46
VENT FAN .....	46
COOKTOP LIGHTS .....	47
TURNTABLE ON / OFF .....	47
MAINTENANCE .....	48

## Microwave Safe Materials

Utensils	Remarks
Browning dish	Follow manufacturer* instructions. The bottom of browning dish must be at least 3/16 inch (5mm) above the turntable. Incorrect usage may cause the turntable to break.
Dinnerware	Microwave-safe only. Follow manufacturer's instructions. Do not use cracked or chipped dishes.
Glass jars	Always remove lid. Use only to heat food until just warm. Most glass jars are not heat resistant and may break.
Glassware	Heat-resistant oven glassware only. Make sure there is no metallic trim. Do not use cracked or chipped dishes.
Oven cooking bags	Follow manufacturer* instructions. Do not close with metal tie. Make slits to allow steam to escape.
Paper plates and cups	Use for short term cooking/warming only. Do not leave oven unattended while cooking.
Paper towels	Use to cover food for reheating and absorbing fat. Use with supervision for a short-term cooking only.
Parchment paper	Use as a cover to prevent splattering or a wrap for steaming.
Plastic	Microwave-safe only. Follow the manufacturer* instructions. Should be labeled "Microwave Safe". Some plastic containers soften, as the food inside gets hot. "Boiling bags" and tightly closed plastic bags should be slit, pierced or vented as directed by package.
Plastic wrap	Microwave-safe only. Use to cover food during cooking to retain moisture. Do not allow plastic wrap to touch food.
Thermometers	Microwave-safe only (meat and candy thermometers).
Wax paper	Use as a cover to prevent splattering and retain moisture.

## Do Not Use in Microwave

Utensils	Remarks
Aluminum tray	May cause arcing. Transfer food into microwave-safe dish.
Food carton with metal handle	May cause arcing. Transfer food into microwave-safe dish.
Metal or metal-trimmed utensils	Metal shields the food from microwave energy. Metal trim may cause arcing.
Metal twist ties	May cause arcing and could cause a fire in the oven.
Paper bags	May cause a fire in the oven.
Plastic foam	Plastic foam may melt or contaminate the liquid inside when exposed to high temperature.
Wood	Wood will dry out when used in the microwave oven and may split or crack.

# SETTING UP THE MICROWAVE

## FRONT VIEW

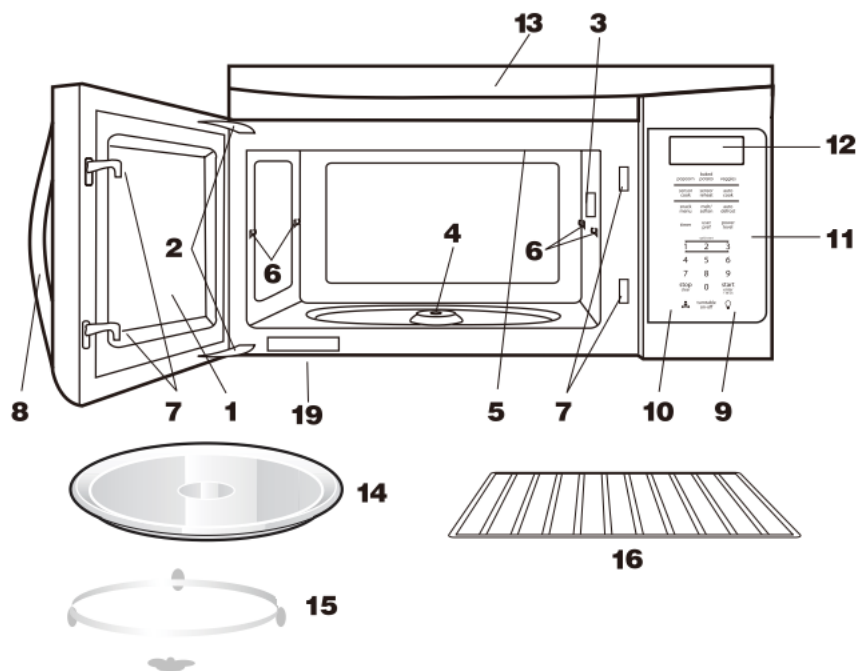

## BOTTOM VIEW

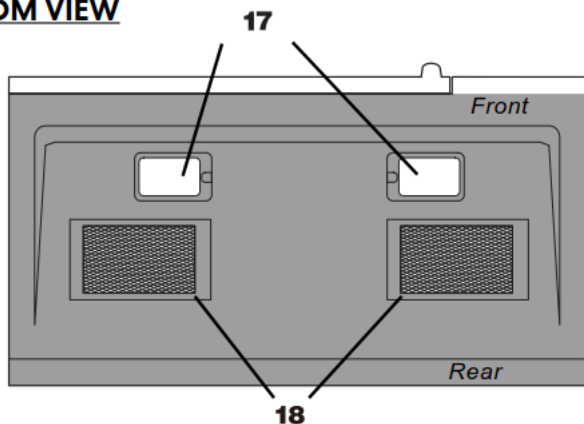

# PARTS LIST

- 1 Microwave oven door with see-through window
- 2 Door hinges
- 3 Waveguide cover:  
DO NOT REMOVE.
- 4 Turntable motor shaft
- 5 Microwave oven light  
It will light when microwave oven is operating or door is open.
- 6 Rack holders
- 7 Safety door latches  
The microwave oven will not operate unless the door is securely closed.
- 8 Handle
- 9 Light hi/lo/off pad  
Press the **light hi/lo/off** pad once for high, twice for low and three times to turn off the light.
- 10 Vent hi/lo/off pad  
Press the **vent hi/lo/off** pad once for high speed, twice for low speed and three times to turn off the fan.
- 11 Auto-Touch control panel
- 12 Time display: Digital display, 99 minutes, 99 seconds
- 13 Ventilation openings
- 14 Removable turntable  
The turntable will rotate clockwise or counter-clockwise. Only remove for cleaning.
- 15 Removable turntable support  
First, carefully place the turntable support in the motor shaft in the center of the microwave oven floor. Place the support ring on the microwave oven floor. Then, place the turntable on the turntable support securely.
- 16 Rack for 2-level cooking/ reheating
- 17 Light cover
- 18 Grease filters
- 19 Menu label

# CONTROL PANEL

The 7-digit Interactive Display spells out operating steps and shows cooking hints.

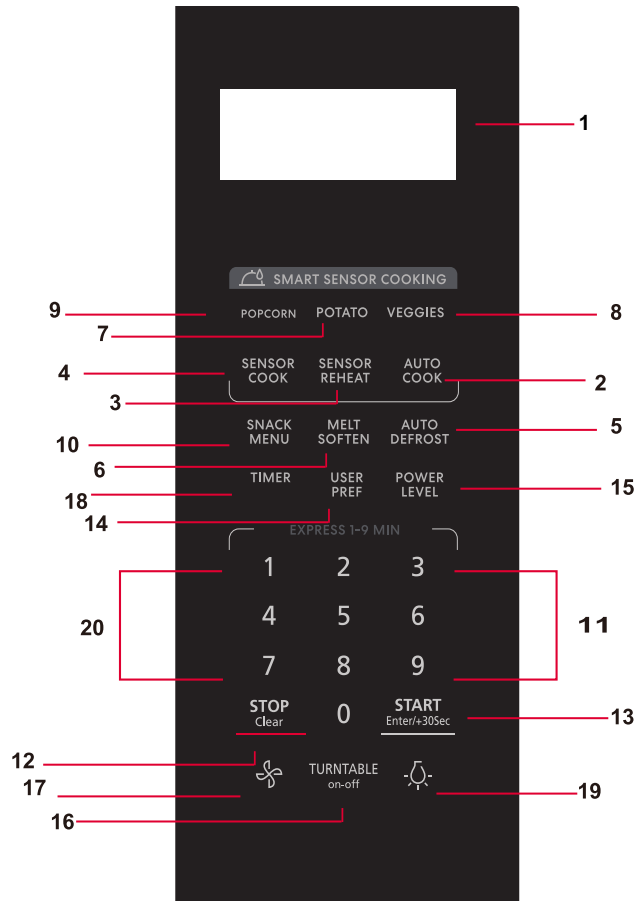
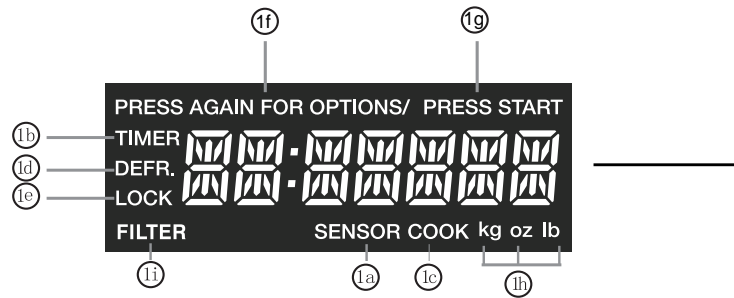

Number next to the control panel key illustration indicates pages on which there are feature descriptions and usage information.

## (1) Display:

The display includes a clock and indicators that show the time of day, cooking time settings, cook powers, sensor, quantities, weights and cooking functions selected.

### 1a. SENSOR:

Icon displayed when using sensor cook.

### 1b. TIMER:

Icon displayed when timer is being set or running.

### 1c. COOK:

Icon displayed when starting microwave cooking.

### 1d. DEFR:

Icon displayed when defrosting food.

### 1e. LOCK:

Icon displayed in control lock.

### 1f. PRESS AGAIN FOR OPTIONS:

Icon displayed when additional options are available.

### 1g. PRESS START:

Icon displayed when a valid function can be started.

### 1h. kg, oz, lb:

Icon displayed when choosing the weight.

### 1i. FILTER:

When Icon is displayed, replace PureAir® Filter.

## (2) Auto Cook

## (3) Sensor Reheat (5 different settings)

## (4) Sensor Cook

## (5) Auto Defrost

## (6) Melt /Soften

## (7) Potato (1-4 potatoes)

## (8) Veggies

## (9) Popcorn

## (10) Snack menu

## (11) Numeric pads (0 thru 9)

## (12) Stop/Clear

## (13) START Enter /+30sec

## (14) User pref

## (15) Power Level (11 power levels available)

## (16) Turntable (On-Off)

## (17) Exhaust (High/Low/Off) ~ Use to turn the exhaust fan off, or to adjust fan speed.

## (18) Timer (On-Off)

## (19) Surface Light (High/Low/Off) ~ Press this pad to adjust the brightness of surface lights.

## (20) Quick Start (9 instant key settings)

- Before operating your new oven, make sure you read and understand this Use and Care Guide completely.
- The clock can be disabled when the microwave is first plugged in and the STOP key is selected. To re-enable the clock, follow below instructions.

### To Set the Clock

- Suppose you want to enter the correct time of day 10:59

Touch:	Display Shows:
1. User pref	
2. 1 0 5 9	10:59
3. START enter +30Sec	10:59

### NOTE

1. If you begin to enter in an incorrect time (e.g. 2:89) the 8 is an invalid digit and cannot be entered. Enter the correct time.
2. If you touch STOP  
clear while setting the clock, the display will show the last time of day set or a blank display if no time of day has been set.

### STOP clear

Press the STOP  
clear to:



1. Erase if you make a mistake during programming.
2. Cancel timer setting and the signal after cooking.
3. Stop the oven temporarily during cooking.
4. Return the time of day to the display.
5. Cancel a program during cooking, press twice.

## MANUAL COOKING

### Timed Cooking

Your Over The Range Microwave Oven can be programmed for 99 minutes, 99 seconds (99:99). Always enter the seconds after the minutes, even if they are both zeros.

Suppose you want to cook for 5 minutes, 30 seconds at 100% power;

Touch:	Display Shows:
1. (5) (3) (0)	5:30 <sup>PRESS START</sup>
2. START enter +30Sec	5:30 <sup>COOK</sup> Time counting down

### Pause Cooking

- You can stop the oven during a cycle by opening the door. The oven stops heating and the fan turns off, but the light stays on.
- To restart cooking, close the door and touch [START enter+30Sec] button.
- If you do not want to continue cooking, open the door and touch STOP/Clear

### Using One Touch Start

This is a time saving pad that will automatically start cooking 2 seconds after selected. Numeric keys 1, 2, or 9 can be touched for a 1 minute, 2 minute or 9 minute *automatic start* cooking feature.

Touch:	Display Shows:
1. (2)	2:00 <sup>COOK</sup> Time counting down

# MANUAL COOKING

## Using Add 30 Sec.

This is a time-saving pad. It is a simplified feature that lets you quickly set and start microwave cooking at 100% power.

- Suppose you want to cook for one minute.

---

Touch:	Display Shows:
--------	----------------

---

1. <b>START</b> enter +30Sec	:30 <small>COOK</small>
------------------------------------	----------------------------

2. <b>START</b> enter +30Sec	1:00 <small>COOK</small> Time counting down
------------------------------------	---

### NOTE

"Food" will be displayed if a quick start cooking cycle or +30 sec key is not selected within 5 minutes of placing food in the microwave. You must open then close the door again to clear "Food" from the display.

## Setting Timed Cooking With Power Level

This feature lets you program a specific cook time and power. For best results, there are 10 power level settings in addition to HIGH (100%) power.

- Suppose you want to cook for 5 minutes, 30 seconds at 80% power.

---

Touch:	Display Shows:
--------	----------------

---

1. (5) (3) (0)	5:30 <small>PRESS START</small>
----------------	------------------------------------

2. <b>Power Level</b> x 3 [100] [90] [80]	<small>PRESS START</small> PL-80
--	-------------------------------------

3. <b>START</b> enter +30Sec	5:30 <small>COOK</small> Time counting down
------------------------------------	---

### NOTE

If you do not select a power level, the oven will automatically cook at HIGH (100%) power.



## Setting Two-Stage Cooking

For best results, some recipes call for different power levels during a cook cycle. You can program your oven for two power level stages during the cooking cycle.

- Suppose you want to set a 2-stage cook cycle. The first stage is a 3 minute cook time at 80% cook power then a 7 minute cook time at 50% cook power.

Touch:

Display Shows:

1. (3) (0) (0)

To set a 3 minute cook time for first stage.

PRESS START  
3:00

2. Power Level x 3

PRESS START  
PL-80

3. (7) (0) (0)

To set a 7 minute cook power for the second stage.

PRESS START  
7:00

4. Power Level x 6

PRESS START  
PL-50

### NOTE

You can program a "0" power second stage for standing time inside the oven.

5. START  
enter  
+30Sec

3:00  
COOK  
Time counting down

## To Set Power Level

There are eleven preset power levels. Using lower power levels increases the cooking time which is recommended for foods such as cheese, milk and long slow cooking of meats. Consult cookbook or recipes for specific recommendations.

PRESS POWER LEVEL PAD NUMBER OF TIMES FOR DESIRED POWER	APPROXIMATE PERCENTAGE OF POWER	COMMON WORDS FOR POWER LEVELS
POWER LEVEL x 1	100%	High
POWER LEVEL x 2	90%	
POWER LEVEL x 3	80%	
POWER LEVEL x 4	70%	Medium High
POWER LEVEL x 5	60%	
POWER LEVEL x 6	50%	Medium
POWER LEVEL x 7	40%	
POWER LEVEL x 8	30%	Med Low/Defrost
POWER LEVEL x 9	20%	
POWER LEVEL x 10	10%	Low
POWER LEVEL x 11	0%	



IMPORTANT

## Using the Rack

The rack allows several foods to be cooked or reheated at one time. However, for the best cooking and reheating, use Turntable ON function and cook with SENSOR COOKING or AUTO COOKING without the rack. When the rack is used, set time and power level manually. Allow plenty of space around and between the dishes. Pay close attention to the cooking and reheating progress. Reposition the foods and reverse them from the rack to turntable and/or stir them at least once during any cooking or reheating time. After cooking or reheating, stir if possible. Using a lower power level will assist in better cooking and reheating uniformity.

### Avoid:

- Storing the rack in the microwave oven when not in use.
- Popping popcorn with the rack in the microwave oven.
- Using any browning dish on the rack.
- Using SENSOR COOKING and AUTO COOKING with the rack.
- Cooking directly on the rack—use microwave-safe cookware.

### NOTE

Turntable on/off function can be used in Manual Operation. See page 47.

## Manual Defrost

If the food that you wish to defrost is not listed on the Defrost chart or is above or below the limits in the Amount column on the Defrost chart (see page 35-36), you need to defrost manually.

You can defrost any frozen food, either raw or previously cooked, by using power level for 30%.

For either raw or previously cooked frozen food the rule of thumb is approximately 4 minutes per pound. For example, defrost 4 minutes for 1 pound of frozen spaghetti sauce.

Always stop the oven periodically to remove or separate the portions that are defrosted. If food is not defrosted at the end of the estimated defrosting time, program the oven in 1 minute increments on power level 30% until totally defrosted.

When using plastic containers from the freezer, defrost only long enough to remove from the plastic in order to place in a microwave-safe dish.

# SENSOR COOKING

Sensor cooking has an electronic controlled sensor that detects the vapor (moisture and humidity) emitted from the food as it heats. The sensor adjusts the cooking times and power level for various foods and quantities automatically.

## Using Sensor Settings:

1. Be sure the exterior of the cooking container and the interior of the oven are dry. Wipe off any moisture with a dry cloth or paper towel.
2. The oven works with foods at normal storage temperature. For example, popcorn would be at room temperature.
3. More or less food than the quantity listed in the chart should be cooked following the guidelines in any microwave cookbook.
4. During the first part of SENSOR COOKING, food name will appear in the display. Do not open the oven door or press the **STOP clear** pad during this part of the cycle. The measurement of vapor will be interrupted. When the sensor detects the vapor emitted from the food, remainder of cooking time will appear. Door may be opened when remaining cooking time appears in the display. At this time, you may stir or season food, as desired.
5. If the sensor does not detect vapor properly when popping popcorn, the oven will turn off, and the correct time of day will be displayed. If the sensor does not detect vapor properly when cooking other foods, AN ERROR CODE will be displayed, and the oven will turn off.
6. Check food for temperature after cooking. If additional time is needed, continue to cook manually.

## Covering Foods:

Some foods cook better when covered.

1. Casserole lid.
2. Plastic wrap: Use plastic wrap recommended for microwave cooking. Cover dish loosely; allow approximately 1/2 inch to remain uncovered to allow steam to escape. Plastic wrap should not touch food.
3. Wax paper: Cover dish completely; fold excess wrap under dish to secure. If dish is wider than paper, overlap two pieces at least one inch to cover.

Be careful when removing any covering to allow steam to escape away from you.





# NOTES for SENSOR COOKING

1. The final cooking result will vary according to the food condition (e.g. initial temperature, shape, quality). Check food for temperature after cooking. If additional time is needed, continue to cook manually.
2. Stay near the oven while it's in use and check cooking progress frequently so that there is no chance of overcooking food.
3. When SENSOR COOKING is selected Turntable On is automatically set for optimum cooking.

## Sensor Cook

You can cook foods by pressing the **sensor cook** pad multiple times. You don't need to calculate cooking time or power level.

- Suppose you want to cook frozen breakfast .

Touch:	Display Shows:
1. Sensor Cook	<small>PRESS AGAIN FOR OPTIONS/ PRESS START</small>  <small>SENSOR</small>
2. Sensor Cook	<small>PRESS AGAIN FOR OPTIONS/ PRESS START</small>  <small>SENSOR</small>
3. Sensor Cook	<small>PRESS AGAIN FOR OPTIONS/ PRESS START</small>  <small>SENSOR</small>
4. Sensor Cook	<small>PRESS AGAIN FOR OPTIONS/ PRESS START</small>  <small>SENSOR</small>
5. START enter +30Sec	 <small>SENSOR COOK</small>







# SENSOR COOKING

## Sensor Cook chart

FOOD	AMOUNT	PROCEDURE
1. Bacon	1-3 slices	Place bacon strips on a microwave bacon rack for best results. (Use dinner plate lined with paper towels if rack is not available).
2. Frozen Dinner	10 oz./ 20 oz.	Place in an appropriately sized microwave container. Cover with plastic wrap . After cooking, stir and allow to stand for 3 minutes.
3. Rice	1-2 cups	Place rice and twice as much liquid (water, chicken or vegetable stock) in a 2 quart microwave dish. Cover with plastic wrap and vent. After cooking, allow to stand for 10 minutes. Stir for fluffier rice.
4. Frozen breakfast	8-12 oz.	Place in an appropriately sized microwave container. Cover with plastic wrap . After cooking, stir and allow to stand for 3 minutes.

## Sensor Reheat

- Suppose you want to reheat rolls with sensor reheat.

Touch:	Display Shows:	Touch:	Display Shows:
1. Sensor Reheat		5. Sensor Reheat	
2. Sensor Reheat		6. START enter +30Sec	
3. Sensor Reheat			
4. Sensor Reheat			

## Sensor Reheat chart

FOOD	AMOUNT	PROCEDURE
Beverage	1 - 3 cups	To reheat beverages. Stir liquid briskly before and after heating to avoid "eruption".
Dinner Plate	1-2 Plates	Place on a low plate. Cover with vented plastic wrap. Let stand 3 minutes after cooking.
Soup/Sauce	1 Cup	Place in shallow microwavable casserole. Cover with vented plastic wrap. After cooking, stir and let stand 3 minutes.
Casserole/ Lasagna	10.5 Oz	Place in a microwavable bowl or casserole. Cover with vented plastic wrap. After cooking, stir and let stand 3 minutes.
Roll/Muffin	1-3 Pieces	Place on paper towel. Do not cover.

# ONE TOUCH COOK

## Popcorn

The Popcorn quick touch pad lets you pop 3.3, 3.0, 1.75 ounce bags of commercially packaged microwave popcorn. Pop only one package at a time. If you are using a microwave popcorn popper, follow manufacturer's instructions.

- Suppose you want to pop a 3.3 oz. popcorn.

Touch:	Display Shows:
1. Popcorn	
2. START enter +30Sec	

Time counting down

Amount	Press popcorn pad
3.30 oz.	once
3.00 oz.	2 times
1.75 oz.	3 times



## NOTES

- Remove the metal shelf from microwave oven when cooking popcorn. Do not use regular paper bags. Do not re-pop unpopped kernels. Do not pop popcorn in glass cookware.

## Veggies

There are 3 options (Frozen Vegetables, Fresh Vegetables) under the Veggies.

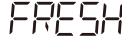
- Suppose you want to cook two cups of frozen veggies.

Touch:	Display Shows:
1. VEGGIES	
2. VEGGIES	
3. START Enter/+30Sec	

Time counting down

## Vegetables chart

FOOD	AMOUNT	PROCEDURE
(Initial temperature)		
1. Frozen Veggies (-18 °C)	2 Cups	Add no water. Cover with lid or plastic wrap. Press the VEGGIES pad two times for frozen vegetables. After cooking, stir and let stand - covered for 3 minutes.
2. Fresh Veggies (5 °C)	2 Cups	
Broccoli Brussels sprouts Cabbage Cauliflower (flowerets) Cauliflower (whole) Spinach Zucchini		Wash and place in casserole. Add no water if vegetables have just been washed. Cover with lid for tender-vegetables or plastic wrap for tender-crisp vegetables. Press the VEGGIES pad one time for fresh vegetables. After cooking, stir if possible. Let stand, -covered for 2 to 5 minutes.
Carrots, sliced Corn on cob Green beans Winter squash -diced halves		Place in casserole. Add 1-4 tbsp. water. Cover with lid for tender vegetables. Use plastic wrap cover for tender-crisp vegetables. Press the VEGGIES pad one time for fresh vegetables. After cooking, stir if possible. Let stand - covered for 2 to 5 minutes.

# ONE TOUCH COOKING

## Snack Menu

Snack Menu is for cooking/heating foods that take a short amount of time!

- Suppose you want to reheat 3 hotdogs.

Touch:	Display Shows:	Touch:	Display Shows:
1. Snacks	FROZEN PIZZA	4. (3)	3
2. Snacks	HOT DOGS	5. START	HOT DOGS
3. START	1-6	Enter/+30Sec	Time counting down

### Snack Menu chart

FOOD	AMOUNT	PROCEDURE
1. Frozen MW Pizza	(6 - 8 oz)	Use for frozen microwave pizza. Remove from package and unwrap. Follow package directions for use of package and/or silver crisping disk.
2. Hot Dogs	1 - 6 Pieces	Place hot dog in bun. Wrap each with paper towel or napkin.
3. Meal in a Cup	2.39 oz	This setting is ideal for individual portions of canned food packed in a small microwaveable container, usually 6 to 8 ounces. Remove inner metal lid and replace outer microwaveable lid. After cooking, stir food and allow to stand 1 or 2 minutes.
4. Frozen Kid's Meal	1 - 2 Servings	Use this pad for frozen, convenience foods. It will give satisfactory results for most brands. You may wish to try several and choose your favorite. Remove package from outer wrapping and follow package directions for covering. After cooking, let stand, covered for 1 to 3 minutes.

## Potato

- Suppose you want to cook 1 to 4 baked Potatoes.

Touch:	Display Shows:
1. Potato	POTATO
2. START	POTATO
Enter/+30Sec	

### NOTES

1. Cooking times are based on an average 8 ounce potato.

### Baked Potato chart

FOOD	AMOUNT	PROCEDURE
Potato*	2 - 4 servings	Pierce with fork in several places. Place on paper towel on turntable. After cooking, remove from oven and let stand for 5 minutes.

\* It is not necessary to enter amount or number.

# ONE TOUCH COOKING

## Setting Melt/Soften

The oven uses low power to melt and soften items. See the following table:

- Suppose you want to melt 2 sticks of Butter.

Touch:	Display Shows:
1. Melt/Soften	MELT BUTTER
2. START	ENTER 1-2 STK
enter	
+30Sec	
3. (2)	2 STICK
4. START	MELT BUTTER
enter	
+30Sec	Time counting down

### MELT TABLE

CATEGORY	AMOUNT	DIRECTION
BUTTER	1 or 2 sticks	Unwrap and place in microwavable container. No need to cover butter. Stir at the end of cooking to complete melting.
CHOCOLATE	2, 4 or 8 oz.	Chocolate chips or squares of baking chocolate may be used. Unwrap squares and place in microwavable container. Stir at the end of cycle to complete melting.
SOFTEN ICE CREAM	Pint, 1.5 Quart.	Place container in oven. Ice cream will be soft enough to make scooping easier.
SOFTEN CREAM CHEESE	3 or 8 oz.	Unwrap and place in microwavable container. Cream cheese will be at room temperature and ready for use in recipe.

# AUTO COOKING

## Auto Cook

Auto cook is divided into 2 parts-Quick Meals (Scrambled Eggs, Hot Cereal, Frozen Pizza, Fudge Brownies) and Dinner Recipes (Garlic Shrimp, Asiago Red Potatoes, Roasted Vegetable Medley, Lemon and Shrimp Risotto, White Chicken Chili).

Key	Food	Amount
Auto Cook x1	Scrambled Eggs	1 - 6 Eggs
Auto Cook x2	Hot Cereal	1 - 3 Servings
Auto Cook x3	Frozen Pizza	12 oz
Auto Cook x4	Fudge Brownies	18-19oz
Auto Cook x5	Garlic Shrimp	Per Recipe
Auto Cook x6	Stuffed Mushrooms	Per Recipe
Auto Cook x7		
Auto Cook x8	Roasted Vegetable Medley	Per Recipe
Auto Cook x9	Risotto	Per Recipe
Auto Cook x10		

## <Quick Meals>

- Suppose you want to cook Hot Cereal for 1 serving .

Touch:	Display Shows:
1. <b>AUTO COOK</b>	<small>PRESS AGAIN FOR OPTIONS/ PRESS START</small> SCRAMBLED EGGS
2. <b>AUTO COOK</b>	<small>PRESS AGAIN FOR OPTIONS/ PRESS START</small> HOT CEREAL
3. <b>START</b> Enter/+30Sec	1-3 SERVING
4. <b>3</b>	<small>PRESS START</small> 3 SERVINGS
5. <b>START</b> Enter/+30Sec	<small>COOK</small> HOT CEREAL Time counting down

## NOTES

When AUTO COOK is selected, Turntable On is automatically set for optimum cooking.

### Quick Meals chart

FOOD	AMOUNT	PROCEDURE
1. Scrambled Eggs	1 - 6 eggs	Whisk together egg and milk (use 1/2 tablespoon milk for each egg) in a microwave safe bowl that has been coated with cooking spray. Select "Scrambled Eggs" under the Auto Cook menu and the desired number of eggs to be cooked. Stir half way through cooking time.
2. Hot Cereal	1- 3 servings	Use individual packets or bulk cereal in your favorite variety: oatmeal, oat bran, cream of wheat, farina or wheatena. Follow package directions for the correct amount of water or milk. To prevent boilovers, it is very important to choose a large container because microwave cooking of cereal causes high boiling. Select "Hot Cereal" under the Auto Cook menu and the desired number servings.
3. Frozen Pizza	12 oz	Use for frozen microwave pizza. Remove from package and unwrap. Follow package directions for use of package and/or silver crisping disk.
4. Fudge Brownies	18-19 oz	Prepare brownie mix according to package directions. Spoon batter into an 8 x 8 inch microwave safe glass dish that has been coated with cooking spray. Select "Fudge Brownies" under the Auto Cook menu.

## AUTO COOKING

- Suppose you want to cook Garlic shrimp.

Touch:	Display Shows:
1. Auto Cook	<small>PRESS AGAIN FOR OPTIONS/ PRESS START</small> SCRAMBLED EGGS
2. Auto Cook	<small>PRESS AGAIN FOR OPTIONS/ PRESS START</small> HOT CEREAL
3. Auto Cook	<small>PRESS AGAIN FOR OPTIONS/ PRESS START</small> FROZEN PIZZA
4. Auto Cook	<small>PRESS AGAIN FOR OPTIONS/ PRESS START</small> FUDGE BROWNIES
5. Auto Cook	<small>PRESS AGAIN FOR OPTIONS/ PRESS START</small> GARLIC SHRIMP
6. START +30 Sec	GARLIC SHRIMP <small>COOK</small> Time counting down

## Dinner Recipes

---

### Garlic Shrimp

---

- ¼ cup butter
- 6 cloves garlic, minced
- 2 tablespoons chopped fresh chives
- 2 tablespoons lemon juice
- 1 tablespoon chili pepper paste
- Salt to taste
- 1 pound raw, peeled and deveined large shrimp

Place butter in a 2 quart microwave safe casserole dish with lid. Microwave on High power for 1 minute or until butter is melted. Stir in garlic, and microwave for an additional 1 minute. Stir in chives, lemon juice, chili pepper paste, and salt. Add shrimp, tossing to coat evenly. Cover, and microwave on High power for 5 minutes, or until shrimp is opaque, stirring after 3 minutes. Serve over hot cooked rice if desired.

---

### Asiago Red Potatoes

---

- 1 ¼ pound red potatoes, peeled and thinly sliced
- 2 tablespoons all purpose flour
- ½ teaspoon salt
- 1 ¼ cups milk
- 1 tablespoon butter, melted
- 5 ounces shredded Asiago cheese

Combine potatoes, flour, and salt in a zip top plastic bag; seal bag and shake to coat potatoes. Transfer potatoes to a lightly greased 2 quart microwave safe casserole dish. Add milk and butter, stirring well. Cover and microwave on 80% power for 12 minutes or until potatoes are tender; sprinkle with cheese and microwave on 80% power for an additional 3 minutes or until cheese melts.

---

### Stuffed Mushrooms

---

1 pound whole baby bella mushrooms  
2 tablespoons butter, melted  
1 bunch green onion, chopped  
¼ cup shredded Parmesan cheese  
2 tablespoons bread crumbs  
1 teaspoon lemon juice  
¼ teaspoon garlic pepper  
Crushed red pepper to taste

Remove stems from mushrooms and set aside.  
Arrange mushroom caps on microwave safe plate.  
Finely chop reserved mushroom stems. Combine butter, chopped mushroom stems, and green onion in a 1 quart microwave safe dish; microwave on High power for 2 minutes. Add remaining ingredients and mix well. Spoon stuffing into mushroom caps. Microwave on High power for 4 to 5 minutes, or until mushrooms are tender.

---

### Roasted Vegetables Medley

---

1 cup baby carrots  
1 cup sliced yellow squash  
1 cup sliced zucchini  
½ cup sliced red bell pepper  
½ cup thinly sliced onion  
1 tablespoon butter  
Garlic and herb seasoning to taste

Combine carrots, squash, zucchini, bell pepper, and onion in a 2 quart microwave safe casserole dish. Dot with butter and sprinkle with seasoning. Cover, and microwave on High power for 8 minutes or to desired degree of doneness.

---

### White Chicken Chili

---

1 pound boneless, skinless chicken breast, cubed  
½ cup chopped onion  
3 garlic cloves, minced  
1 (15 ounce) can white beans, drained  
1 (4 ounce) can chopped green chili pepper  
1 cup chicken broth  
1 ½ teaspoon chili powder  
¾ teaspoon cumin  
½ teaspoon salt  
½ teaspoon black pepper  
½ cup chopped fresh cilantro  
2 tablespoons fresh lime juice

Combine chicken, onion, and garlic in a 2.5 quart microwave safe dish. Cover, and microwave on High for 6 minutes, or until chicken is fully cooked and onion is tender, stirring after 3 minutes.

Add white beans, chili pepper, chicken broth, chili powder, cumin, salt and pepper, stirring well. Cover and microwave on High for 10 minutes, stirring after 5 minutes.

Stir in cilantro and lime juice before serving.



## Lemon and Shrimp Risotto

- 2 teaspoons butter
- 2 teaspoons olive oil
- 2 tablespoons finely chopped shallot
- 4 cups chicken broth
- ¼ cup fresh squeezed lemon juice
- 2 cups risotto
- 1 pound medium shrimp, peeled and deveined
- 1 cup frozen peas, thawed
- 2 teaspoons grated lemon zest
- ¼ teaspoon black pepper
- ¾ teaspoon salt

Combine butter, olive oil, and shallot in a 1 quart microwave safe dish. Microwave on High for 1 minute or until shallot is tender. Set aside.

Combine chicken broth and lemon juice in a 2 quart microwave safe measuring cup or casserole dish. Cover with lid or vented plastic wrap. Microwave on High power for 10 minutes. Stir in reserved shallot mixture and risotto. Cover and continue to microwave on 50% power for 20 minutes. Stir in shrimp, peas, grated lemon zest, pepper, and salt. Cover and microwave on 50% power for 5 minutes or until shrimp is opaque.

## AUTO DEFROST

AUTO DEFROST

### Using Auto Defrost







The auto defrost feature provides you with the best defrosting method for frozen foods. The cooking guide will show you which defrost sequence is recommended for the food you are defrosting.

For added convenience, the Auto Defrost includes a built-in beep mechanism that reminds you to check, turn over, separate, or rearrange the food in order to get the best defrost results. Three different defrosting levels are provided:

1. MEAT
2. POULTRY
3. FISH

Available weight is 0.1-6.0 lbs

- Suppose you want to defrost 1.2 lbs of fish.

Touch:	Display Shows:
1. 	PRESS AGAIN FOR OPTIONS/ PRESS START MEAT
2. 	PRESS AGAIN FOR OPTIONS/ PRESS START POULTRY
3. 	PRESS AGAIN FOR OPTIONS/ PRESS START FISH
4. 	ENTER WEIGHT lb
5.  To enter weight	PRESS START 1.2 lb
6. 	DEFR. FISH Time counting down

### NOTES

The oven will beep during the DEFROST cycle. At this time, open the door and turn, separate, or rearrange the food. Remove any portions that have thawed. Return frozen portions to the oven and touch **START** to resume the defrost cycle.  
+30 Sec

## Operating Tips

- For best results, remove fish, shell fish, meat and poultry from its original closed paper or plastic package (wrapper). Otherwise, the wrap will hold steam and juice close to the foods, which can cause the outer surface of the foods to cook.
- For best results, roll your ground meat into a ball before freezing. During the DEFROST cycle, the microwave will signal when it is time to turn the meat over. Scrape off any excess frost from the meat and continue defrosting.
- Place foods in a shallow container or on a microwave roasting rack to catch drippings.

This table shows food type selections and the weights you can set for each type. For best results, loosen or remove covering on food.

KEYPRESS	Category	WEIGHTS YOU CAN SET (tenths of a pound)
Auto Defrost x 1	Meat	0.1 to 6.0 lbs
Auto Defrost x 2	Poultry	0.1 to 6.0 lbs
Auto Defrost x 3	Fish	0.1 to 6.0 lbs

### Weight conversion table

You are probably used to measuring food in pounds and ounces that are fractions of a pound (for example, 4 ounces equals 1/4 pound). However, in order to enter food weight in Auto Defrost, you must specify pounds and tenths of a pound.

If the weight on the food package is in fractions of a pound, you can use the following table to convert the weight to decimals.

OUNCES	Equivalent Weight DECIMAL WEIGHT
1.6	.10
3.2	.20
4.0	.25 One-Quarter Pound
4.8	.30
6.4	.40
8.0	.50 One-Half Pound
9.6	.60
11.2	.70
12.0	.75 Three-Quarters Pound
12.8	.80
14.4	.90
16.0	1.0 One Pound

## NOTES

If between two decimal weights, choose the lower weight for the best defrosting results.

## AUTO DEFROST

### Auto Defrost Table

**NOTE:** Meat of irregular shape and large, fatty cuts of meat should have the narrow or fatty areas shielded with foil at the beginning of the defrost sequence.

### Meat Settings

FOOD	SETTING	AT BEEP	SPECIAL INSTRUCTIONS
<b>BEEF</b>			
Ground Beef, Bulk	MEAT	Remove thawed portions with fork. Turn over. Return remainder to oven.	Do not defrost less than 1/4 lb. Freeze in ball shape.
Ground Beef, Patties	MEAT	Separate and rearrange.	Do not defrost less than 2 oz. patties. Depress center when freezing.
Round Steak	MEAT	Turn over. Cover warm areas with aluminum foil.	Place in a microwave safe dish.
Tenderloin Steak	MEAT	Turn over. Cover warm areas with aluminum foil.	Place in a microwave safe dish.
Stew Beef	MEAT	Remove thawed portions with fork. Separate remainder.	Place in a microwave safe dish.
Pot Roast, Chuck Roast	MEAT	Return remainder to oven.	Place in a microwave safe dish.
Rib Roast	MEAT	Turn over. Cover warm areas with aluminum foil.	Place in a microwave safe dish.
Rolled Rump Roast	MEAT	Turn over. Cover warm areas with aluminum foil.	Place in a microwave safe dish.
<b>LAMB</b>			
Cubes for Stew	MEAT	Turn over. Cover warm areas with aluminum foil.	Place in a microwave safe dish.
Chops (1 inch thick)	MEAT	Remove thawed portions with fork. Return remainder to oven.	Place in a microwave safe dish.
<b>PORK</b>			
Chops (1/2 inch thick)	MEAT	Separate and rearrange.	Place in a microwave safe dish.
Hot Dogs	MEAT	Separate and rearrange.	Place in a microwave safe dish.
Spareribs Country-style Ribs	MEAT	Turn over. Cover warm areas with aluminum foil.	Place in a microwave safe dish.
Sausage, Links	MEAT	Separate and rearrange.	Place in a microwave safe dish.
Sausage, Bulk	MEAT	Remove thawed portions with fork. Turn over. Return remainder to oven.	Place in a microwave safe dish.
Loin Roast, Boneless	MEAT	Turn over. Cover warm areas with aluminum foil.	Place in a microwave safe dish.

## AUTO DEFROST

### Auto Defrost Table (Continued)

#### Poultry Settings

FOOD	SETTING	AT BEEP	SPECIAL INSTRUCTIONS
<b>CHICKEN</b> Whole (up to 6 lbs)	POULTRY	Turn over breast side down. Cover warm areas with aluminum foil.	Place chicken breast-side up in a microwave safe dish. Finish defrosting by immersing in cold water. Remove giblets when chicken is partially defrosted.
		Separate pieces and rearrange.	Place in a microwave safe dish.
Cut-up		Turn over. Cover warm areas with aluminum foil.	Finish defrosting by immersing in cold water.
<b>CORNISH HENS</b> Whole	POULTRY	Turn over. Cover warm areas with aluminum foil.	Place in a microwave safe dish. Finish defrosting by immersing in cold water.
<b>TURKEY</b> Breast (up to 6 lbs)	POULTRY	Turn over. Cover warm areas with aluminum foil.	Place in a microwave safe dish. Finish defrosting by immersing in cold water.

#### Fish Settings

FOOD	SETTING	AT BEEP	SPECIAL INSTRUCTIONS
<b>FISH</b> Fillets	FISH	Turn over. Separate fillets when partially thawed, if possible.	Place in a microwave safe dish. Carefully separate fillets under cold water.
Steaks	FISH	Separate and rearrange.	Place in a microwave safe dish. Run cold water over to finish defrosting.
Whole	FISH	Turn over	Place in a microwave safe dish. Cover head and tail with foil; do not let foil touch sides of microwave. Finish defrosting by immersing in cold water.
<b>SHELLFISH</b>			
Crab meat	FISH	Break apart. Turn over.	Place in a microwave safe dish.
Lobster tails	FISH	Turn over and rearrange.	Place in a microwave safe dish.
Shrimp	FISH	Separate and rearrange.	Place in a microwave safe dish.
Scallops	FISH	Separate and rearrange.	Place in a microwave safe dish.

## AUTO DEFROST

### Defrosting Tips

- When using Auto Defrost, the weight to be entered is the net weight in pounds and tenths of pounds (the weight of the food minus the container).
- Before starting, make sure to remove any and all metal twist-ties that often come with frozen food bags, and replace them with strings or elastic bands.
- Open containers, such as cartons, before placing in the oven.
- Always slit or pierce plastic pouches or packaging.
- If food is foil wrapped, remove foil and place food in a suitable container.
- Slit the skin of skinned food, such as sausage.
- Bend plastic pouches of food to ensure even defrosting.
- Always underestimate defrosting time. If defrosted food is still icy in the center, return it to the microwave oven for more defrosting.
- The length of defrosting time varies according to how solidly the food is frozen.
- The shape of the package affects how quickly food will defrost. Shallow packages will defrost more quickly than a deep block.
- As food begins to defrost, separate the pieces. Separated pieces defrost more easily.
- Use small pieces of aluminum foil to shield parts of food such as chicken wings, leg tips, fish tails, or areas that start to get warm. Make sure the foil does not touch the sides, top, or bottom of the oven. The foil can damage the oven lining.
- For better results, let food stand after defrosting.
- Turn over food during defrosting or standing time. Break apart and remove food as required.

## CONVENIENT FEATURES

### 1. User pref

The microwave oven has settings that allow you to customize the operation for your convenience. Below is the table showing various settings. Touch the USER PREF key multiple times to scroll to the desired setting function.

Key press	Option
User pref x1	Clock
User pref x2	Control Lock
User pref x3	Power Save
User pref x4	Volume Off/ Low/Med/High/
User pref x5	Language
User pref x6	Weight lb/kg
User pref x7	Demo

## (1). Setting Clock

The clock can be disabled when the microwave is first plugged in and the **STOP**  
Clear key is selected.

To re-enable the clock follow clock instructions.

- Suppose you want to set the clock for 10:59.

---

Touch: Display Shows:

---

1. User pref PRESS AGAIN FOR OPTIONS/  
12:00 ENTER TIME

2. (1) (0) (5) (9) PRESS START  
10:59

3. **START**  
enter  
+30Sec 10:59

### NOTE

1. If you begin to enter in an incorrect time (e.g. 2:89) the 8 is an invalid digit and cannot be entered. Enter the correct time.
2. If you touch **STOP**  
Clear while setting the clock, the display will show the last time of day set or a blank display if no time of day has been set.

## (2).Setting Control Lock On/Off

To turn ON Control Lock .

---

Touch: Display Shows:

---

1. User pref PRESS AGAIN FOR OPTIONS/  
12:00 ENTER TIME

2. User pref PRESS AGAIN FOR OPTIONS/ PRESS START  
CONTROL LOCK

3. **START**  
enter  
+30Sec Time of day  
if time of day was set  
LOCK

To turn OFF the Control Lock, touch User pref

then touch **START**  
enter  
+30Sec

### (3).Setting Power Save On/Off

To turn ON Power Save. Turning ON power save turns off the time of day clock display.

Touch:

Display Shows:

1. User pref

PRESS AGAIN FOR OPTIONS/  
12:00 ENTER TIME

2. User pref

PRESS AGAIN FOR OPTIONS/ PRESS START  
CONTROL LOCK

3. User pref

PRESS AGAIN FOR OPTIONS/ PRESS START  
POWER SAVE OFF

4. START  
enter  
+30Sec

ON

To turn OFF the Power Save, touch User pref and choose POWER SAVE, select OFF then touch START +30 Sec .

### (4).Turning Sound Low/Med/High/Off

Audible signals are available to guide you when setting and using your oven.

- **A programming tone** will sound each time you touch a pad.
- **Three tones** signal the end of a Kitchen Timer count down.
- **Three tones** signal the end of a cooking cycle.
- Suppose you want to turn audible signal off.

Touch:

Display Shows:

1. User pref

PRESS AGAIN FOR OPTIONS/  
12:00 ENTER TIME

2. User pref

PRESS AGAIN FOR OPTIONS/ PRESS START  
CONTROL LOCK

3. User pref

PRESS AGAIN FOR OPTIONS/ PRESS START  
POWER SAVE OFF

4. User pref

PRESS AGAIN FOR OPTIONS/ PRESS START  
VOLUME LOW

PRESS AGAIN FOR OPTIONS/ PRESS START  
VOLUME MED

PRESS AGAIN FOR OPTIONS/ PRESS START  
VOLUME HIGH

PRESS AGAIN FOR OPTIONS/ PRESS START  
VOLUME OFF

5. START  
enter  
+30Sec

OFF

#### NOTE

When the cooking cycle is completed END will be displayed and the audible signal will sound if the sound is turned on.

(5). Setting ordinary filter

- Suppose you want to set the filter

Touch:	Display Shows:
1. User pref	<small>PRESS AGAIN FOR OPTIONS/</small> 12:00 ENTER TIME
2. User pref	<small>PRESS AGAIN FOR OPTIONS/ PRESS START</small> CONTROL LOCK
3. User pref	<small>PRESS AGAIN FOR OPTIONS/ PRESS START</small> POWER SAVE OFF
4. User pref	<small>PRESS AGAIN FOR OPTIONS/ PRESS START</small> VOLUME LOW
5. User pref	<small>PRESS AGAIN FOR OPTIONS/ PRESS START</small> FILTER RESET <small>PRESS AGAIN FOR OPTIONS/ PRESS START</small> FILTER OFF
6. START enter +30Sec	RESET  OFF

 **NOTE**

START  
When enter  
+30Sec is pressed and the previous setting was English it will be set to French. If you want to switch back to English you will have to again press User pref Five Times times and then press START  
enter  
+30Sec .

# CONVENIENT FEATURES

## (6)SETTING LANGUAGE ENGLISH/FRANCAIS

- Suppose you want to set the language

Touch:	Display Shows:
1. User pref	<small>PRESS AGAIN FOR OPTIONS/</small> 12:00 ENTER TIME
2. User pref	<small>PRESS AGAIN FOR OPTIONS/ PRESS START</small> CONTROL LOCK
3. User pref	<small>PRESS AGAIN FOR OPTIONS/ PRESS START</small> POWER SAVE OFF
4. User pref	<small>PRESS AGAIN FOR OPTIONS/ PRESS START</small> VOLUME LOW
5. User pref	<small>PRESS AGAIN FOR OPTIONS/ PRESS START</small> FILTER RESET
6. User pref	<small>PRESS AGAIN FOR OPTIONS/ PRESS START</small> LANGUAGE FRENCH
7. START enter +30Sec	FRANCAIS

## (7).Setting Weight Lb/Kg

- Suppose you want to toggle weight between pounds & kilograms.

Touch:	Display Shows:
1. User pref	<small>PRESS AGAIN FOR OPTIONS/</small> 12:00 ENTER TIME
2. User pref	<small>PRESS AGAIN FOR OPTIONS/ PRESS START</small> CONTROL LOCK
3. User pref	<small>PRESS AGAIN FOR OPTIONS/ PRESS START</small> POWER SAVE OFF
4. User pref	<small>PRESS AGAIN FOR OPTIONS/ PRESS START</small> VOLUME LOW
5. User pref	<small>PRESS AGAIN FOR OPTIONS/ PRESS START</small> FILTER RESET
6. User pref	<small>PRESS AGAIN FOR OPTIONS/ PRESS START</small> LANGUAGE FRENCH
7. User pref	<small>PRESS AGAIN FOR OPTIONS/ PRESS START</small> Lb / Kg
8. START enter +30Sec	Lb <sup>kg</sup> Kg lb

### NOTE

If the display shows kg, pressing the START enter +30Sec. button will reset the oven controls to lbs. To return to kg, you will have to again press User pref six times and then press START enter +30Sec.

## (8).Setting Demo Mode On/Of

- Suppose you want to enter Demo mode. When Demo mode is ON programming functions will work in a rapid countdown mode with no cooking power.

Touch:	Display Shows:
1. User pref	<small>PRESS AGAIN FOR OPTIONS/</small> 12:00 ENTER TIME
2. User pref	<small>PRESS AGAIN FOR OPTIONS/ PRESS START</small> CONTROL LOCK
3. User pref	<small>PRESS AGAIN FOR OPTIONS/ PRESS START</small> POWER SAVE OFF
4. User pref	<small>PRESS AGAIN FOR OPTIONS/ PRESS START</small> VOLUME LOW
5. User pref	<small>PRESS AGAIN FOR OPTIONS/ PRESS START</small> FILTER RESET
6. User pref	<small>PRESS AGAIN FOR OPTIONS/ PRESS START</small> LANGUAGE FRENCH
7. User pref	<small>PRESS AGAIN FOR OPTIONS/ PRESS START</small> Lb / Kg
8. User pref	<small>PRESS AGAIN FOR OPTIONS/ PRESS START</small> DEMO OFF
9. START enter +30Sec	<small>PRESS AGAIN FOR OPTIONS/ PRESS START</small> ON  ON OFF

### NOTE

START enter +30Sec  
When START enter +30Sec is pressed and the previous setting was OFF then it will be set to ON. If you want to turn the demo mode back OFF you will have to again press User pref seven times and then press START enter +30Sec.

## 2. Setting Kitchen Timer

Your microwave oven can be used as a kitchen timer. You can set up to 99 minutes, 99 seconds. The kitchen timer can be used while the microwave oven is running.



- Suppose you want to set for three minutes.

Touch:	Display Shows:
1. Timer	TIMER ENTER TIME
2. (3) (0) (0)	TIMER 3:00 PRESS START
3. START enter +30Sec	TIMER 3:00 Timer starts counting down

## 3. Using Vent Fan

The pad controls the 2-speed vent fan. If the vent fan is OFF the first touch of the Vent pad will turn the fan on HIGH, second touch LOW and third touch OFF.

- Suppose you want to set the vent fan speed to LOW from the OFF position.

Touch:	Display Shows:
1.  Hi   Low   Off	HIGH
2.  Hi   Low   Off	LOW

## NOTE

If the temperature from the range or cooktop below the oven gets too hot, the vent fan will automatically turn on to protect the oven. It may stay on up to an hour to cool the oven. When this occurs, the Vent pad will not turn the fan off.

## 4. Using Cooktop Light

The pad controls the cooktop light. If the light is OFF the first touch of the light pad will turn the light ON (high), second touch Nite (low) and third touch OFF.

- Suppose you want to set the light for HIGH from the OFF position.

Touch:	Display Shows:
1.  Hi   Low   Off	HIGH

## 5. Setting Turntable On/Off

Press **Turntable On-Off** to turn the turntable on or off.

For best cooking results, leave the turntable on. It can be turned off for large dishes.

Touch:	Display Shows:
1. Turntable On-Off	OFF
2. Turntable On-Off	ON

## NOTE

Sometimes the turntable can become hot to the touch during and after cooking. Do not run the oven empty without food in it.



# MAINTENANCE

## Troubleshooting

Check your problem by using the chart below and try the solutions for each problem. If the microwave oven still does not work properly, contact the nearest authorized service center.

TROUBLE	POSSIBLE CAUSE	POSSIBLE REMEDY
Oven will not start	<ul style="list-style-type: none"> <li>a. Electrical cord for oven is not plugged in.</li> <li>b. Door is open.</li> <li>c. Wrong operation is set.</li> </ul>	<ul style="list-style-type: none"> <li>a. Plug into the outlet.</li> <li>b. Close the door and try again.</li> <li>c. Check instructions.</li> </ul>
Arcing or sparking	<ul style="list-style-type: none"> <li>a. Materials to be avoided in microwave oven were used.</li> <li>b. The oven is operated when empty.</li> <li>c. Spilled food remains in the cavity.</li> </ul>	<ul style="list-style-type: none"> <li>a. Use microwave-safe cookware only.</li> <li>b. Do not operate with oven empty.</li> <li>c. Clean cavity with wet towel.</li> </ul>
Unevenly cooked foods	<ul style="list-style-type: none"> <li>a. Materials to be avoided in microwave oven were used.</li> <li>b. Food is not defrosted completely.</li> <li>c. Cooking time, power level is not suitable.</li> <li>d. Food is not turned or stirred.</li> </ul>	<ul style="list-style-type: none"> <li>a. Use microwave-safe cookware only.</li> <li>b. Completely defrost food.</li> <li>c. Use correct cooking time, power level.</li> <li>d. Turn or stir food.</li> </ul>
Overcooked foods	Cooking time, power level is not suitable.	Use correct cooking time, power level.
Undercooked foods	<ul style="list-style-type: none"> <li>a. Materials to be avoided in microwave oven were used.</li> <li>b. Food is not defrosted completely.</li> <li>c. Oven ventilation ports are restricted.</li> <li>d. Cooking time, power level is not suitable.</li> </ul>	<ul style="list-style-type: none"> <li>a. Use microwave-safe cookware only.</li> <li>b. Completely defrost food.</li> <li>c. Check to see that oven ventilation ports are not restricted.</li> <li>d. Use correct cooking time, power level.</li> </ul>
Improper defrosting	<ul style="list-style-type: none"> <li>a. Materials to be avoided in microwave oven were used.</li> <li>b. Cooking time, power level is not suitable.</li> <li>c. Food is not turned or stirred.</li> </ul>	<ul style="list-style-type: none"> <li>a. Use microwave-safe cookware only.</li> <li>b. Use correct cooking time, power level.</li> <li>c. Turn or stir food.</li> </ul>

## IMPORTANT

Do Not Return This Product To The Store If you have a problem with this product, please contact Cosmo Customer Support at

**1-888-784-3108.**

DATED PROOF OF PURCHASE, MODEL #, AND SERIAL #  
REQUIRED FOR WARRANTY SERVICE

## IMPORTANT

Ne pas Réexpédier ce Produit au Magasin  
Pour tout problème concernant ce produit, veuillez contacter  
le service des consommateurs Cosmo Customer Support au

**1-888-784-3108.**

UNE PREUVE D'ACHAT DATEE EST REQUISE POUR BENEFICIER DE LA GARANTIE.

## IMPORTANTE

No regrese este producto a la tienda  
Si tiene algún problema con este producto, por favor contacte el  
AYUDA AL CLIENTE COSMO al

**1-888-784-3108**

(Válido solo en E.U.A).

NECESITA UNA PRUEBA DE DE COMPRA FECHADA, NÚMERO DE  
MODELO Y DE SERIE PARA EL SERVICIO DE LA GARANTÍA



# APPLIANCES

## WARRANTY AND SERVICE

For full warranty details on this product please  
visit:

<http://www.cosmoappliances.com/warranty>

TO RECEIVE WARRANTY SERVICE, YOUR  
PRODUCT MUST BE REGISTERED. TO REGISTER,  
VISIT:

[WWW.COSMOAPPLIANCES.COM/WARRANTY](http://WWW.COSMOAPPLIANCES.COM/WARRANTY)

SCAN TO REGISTER





### **Correct Disposal of this product:**

This marking indicates that this appliance should not be disposed with other household wastes. To prevent possible harm to the environment or human health from uncontrolled waste disposal, recycle it responsibly to promote the sustainable reuse of material resources.



Cosmo is constantly making efforts to improve the quality and performance of our products, so we may make changes to our appliances without updating this manual.

Electronic version of this manual is available at:  
[www.cosmoappliances.com](http://www.cosmoappliances.com)